

CPDZC36V0U-HF

RoHS Device
Halogen Free



Features

- Uni-directional ESD protection.
- IEC 61000-4-5 (surge); IPP=2A.
- IEC 61000-4-2 (ESD); ±25KV(contact).
- Low clamping voltage.
- Low leakage current.

Mechanical data

- Case: 0201/DFN0603 package, molded plastic.
- Terminals: Gold plated, solderable per MIL-STD-750, method 2026.
- Polarity: Color band denotes cathode end.
- Mounting position: Any.
- Weight: 0.0004 grams (approx.).

Circuit Diagram

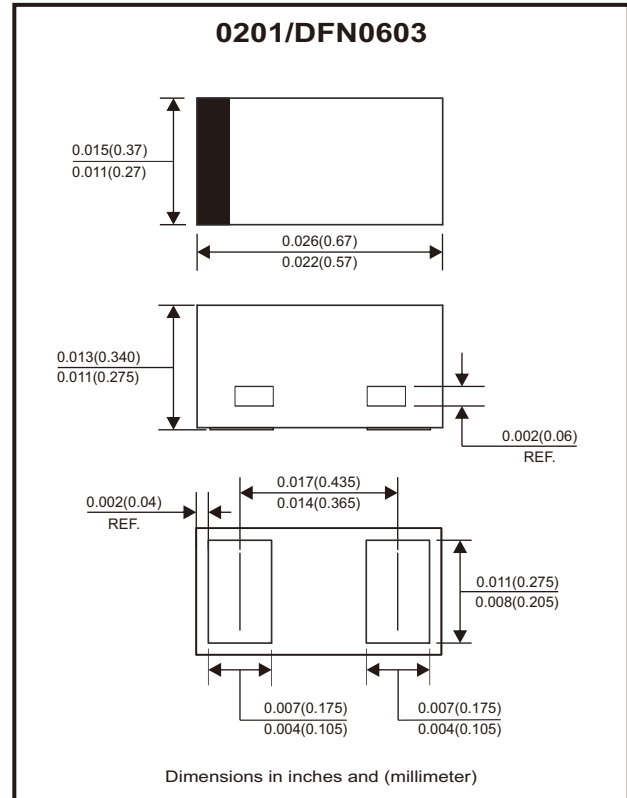

Maximum Rating (at TA=25°C unless otherwise noted)

Parameter	Conditions	Symbol	Value	Unit
Peak pulse power	$T_P = 8/20\mu s$	P_{PP}	130	W
Peak pulse current	$T_P = 8/20\mu s$	I_{PP}	2	A
ESD capability	IEC 61000-4-2(air) IEC 61000-4-2(contact)	ESD	±25	kV
Operating temperature range		T_j	-55 ~ +125	°C
Storage temperature range		T_{STG}	-55 ~ +150	°C

Electrical Characteristics (at TA=25°C unless otherwise noted)

Parameter	Conditions	Symbol	Min	Typ	Max	Unit
Working peak reverse voltage		V_{RWM}			36	V
Forward voltage	$I_F = 10mA$	V_F			900	mV
Breakdown voltage	$I_T = 1mA$	V_{BR}	40			V
Reverse leakage current	$V_{RWM} = 36V$	I_R		10	50	nA
Clamping voltage	$I_{PP} = 1A, T_P = 8/20\mu s$	V_C		50	55	V
	$I_{PP} = 2A, T_P = 8/20\mu s$	V_C		58	65	V
Junction capacitance	$V_R = 0V, f = 1MHz$	C_J		15	20	pF

Typical Rating and Characteristic Curves (CPDZC36V0U-HF)

Fig.1 - 8/20 μ s Peak Pulse Current Waveform Acc. IEC 61000-4-5

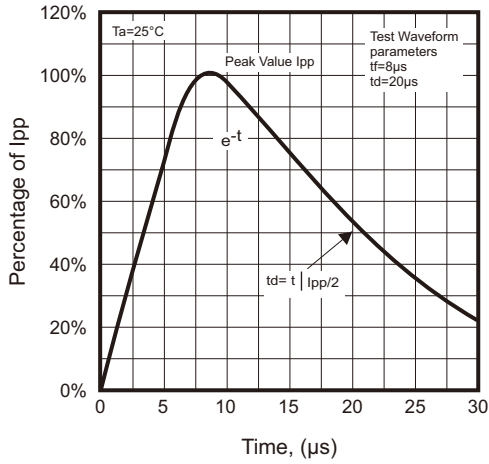

Fig.2 - Power Rating Derating Curve

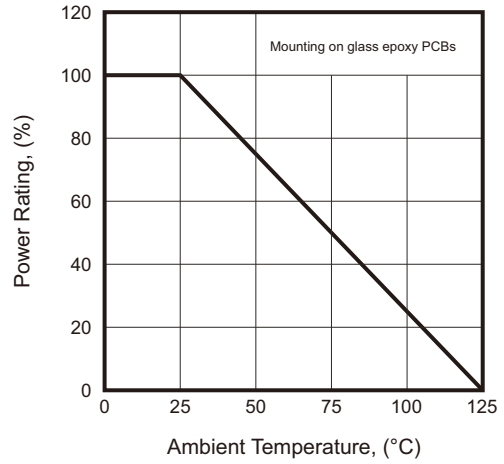

Fig.3 - Typical Clamping Voltage vs. Peak Pulse Current

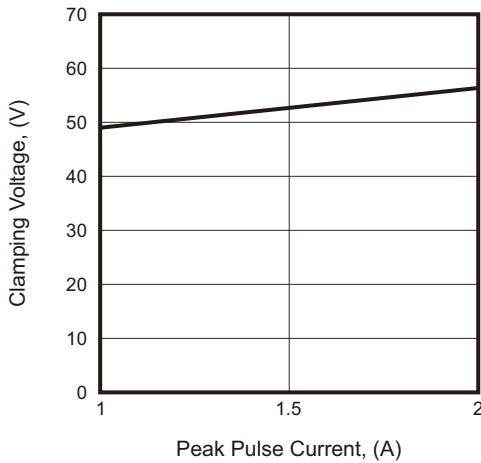

Fig.4 - Typical Capacitance Between Terminals Characteristics

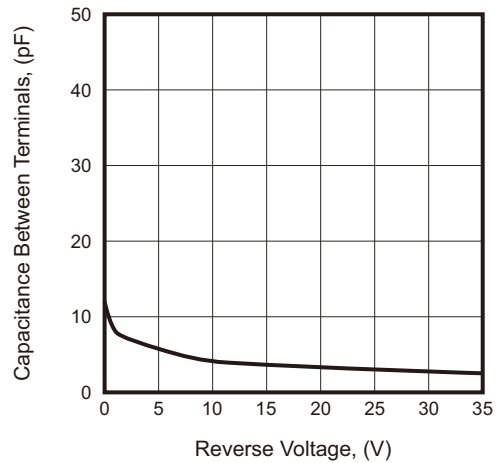
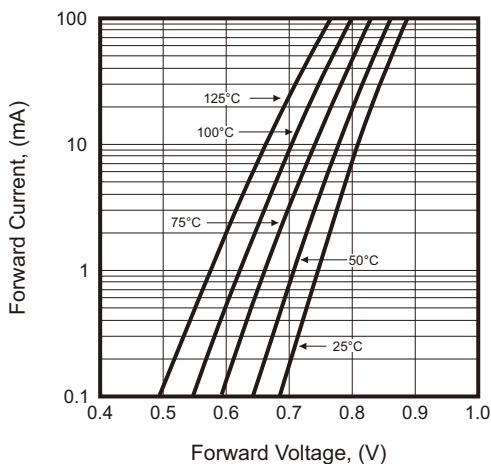
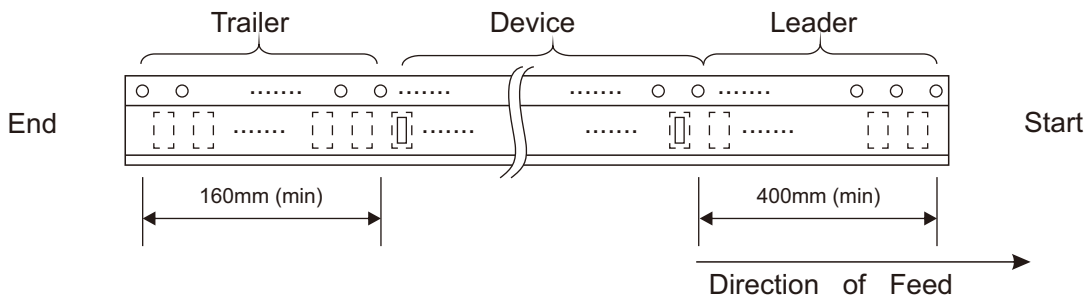
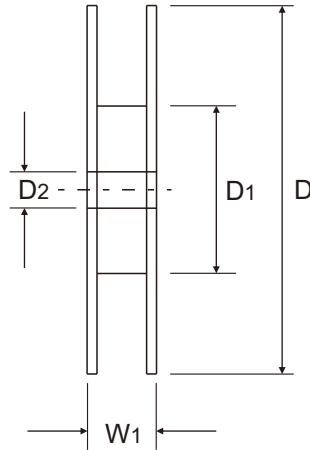
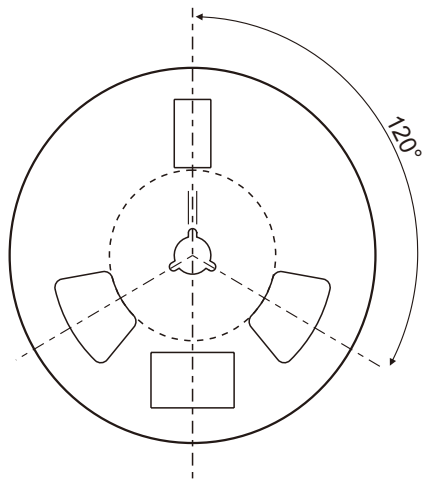
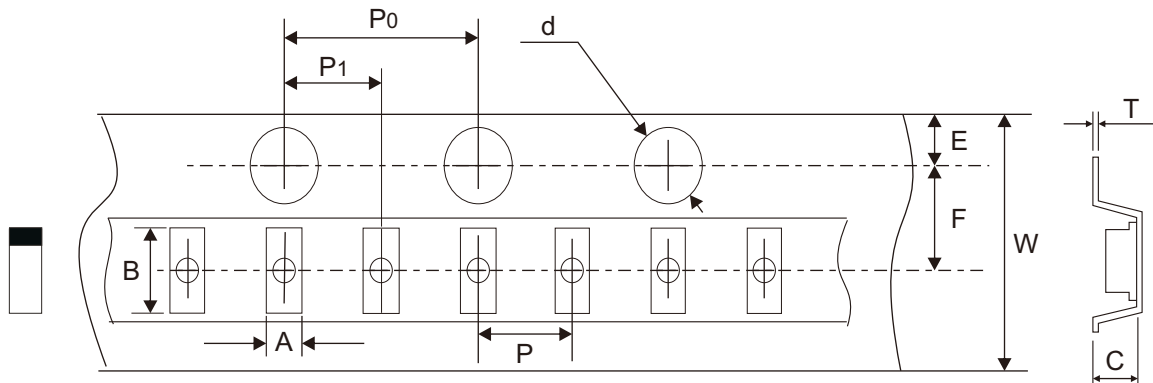

Fig.5 - Forward Characteristic



Reel Taping Specification



0201 (DFN0603)	SYMBOL	A	B	C	d	D	D1	D2
	(mm)	0.44 ± 0.03	0.74 ± 0.03	0.40 ± 0.03	1.50 + 0.10 - 0.00	178.00 ± 1.00	60.00 ± 0.50	13.50 ± 0.20
	(inch)	0.017 ± 0.001	0.029 ± 0.001	0.016 ± 0.001	0.059 + 0.004 - 0.000	7.008 ± 0.039	2.362 ± 0.020	0.531 ± 0.008

0201 (DFN0603)	SYMBOL	E	F	P	P0	P1	T	W	W1
	(mm)	1.75 ± 0.10	3.50 ± 0.05	2.00 ± 0.05	4.00 ± 0.10	2.00 ± 0.05	0.20 ± 0.03	8.00 + 0.30 - 0.10	12.00 + 0.50 - 0.00
	(inch)	0.069 ± 0.004	0.138 ± 0.002	0.079 ± 0.002	0.157 ± 0.004	0.079 ± 0.002	0.008 ± 0.001	0.315 + 0.012 - 0.004	0.472 + 0.020 - 0.000

Marking Code

Part Number	Marking Code
CPDZC36V0U-HF	E36



Suggested P.C.B. PAD Layout

SIZE	0201(DFN0603)	
	(mm)	(inch)
A	0.16	0.006
B	0.24	0.009
C	0.34	0.013
D	0.40	0.016
E	0.64	0.025

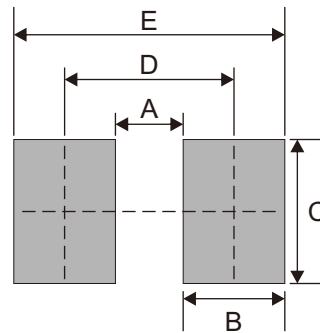

Standard Packaging

Case Type	REEL PACK	
	REEL (pcs)	Reel Size (inch)
0201 (DFN0603)	10,000	7